

**Module SLA DC G2 50mm SNC**

Module SLA essence



SLA DC G2 50mm 700lm SNC



SLA DC G2 50mm 1200lm SNC



**Product description**

- \_ Fits in most existing MR16 / GU10 halogen luminaires
- \_ Replacement of 50 W MR16 halogen lamps or 20 W HID lamp
- \_ Module with integrated heatsink and optics
- \_ Free choice of variable dimming and non-dimming LED drivers
- \_ Pre-wired for quick and easy installation
- \_ Eye-catching lens optic with mirrors halogen facettes
- \_ Long lifetime: L70B50 >50,000 h
- \_ 5 years guarantee (conditions at <https://www.tridonic.com/manufacturer-guarantee-conditions>)

**Optical properties**

- \_ Colour temperatures 2,700, 3,000 and 4,000 K
- \_ Useful luminous flux 1,270 lm/W at Irated and tp = 75 °C
- \_ Efficacy of the LED module 104 lm/W at Irated and tp = 75 °C
- \_ Higher CRI, typical Ra = 92
- \_ Small colour tolerance (MacAdam 3)
- \_ Beam Angle: spot degree (12° / 24°) or downlight (36°)

**Mechanical properties**

- \_ Module dimension ø49.6 x 60 mm and ø49.6 x 70 mm
- \_ Mounting with mounting ring, see accessories

**Website**

<http://www.tridonic.com/28001942>

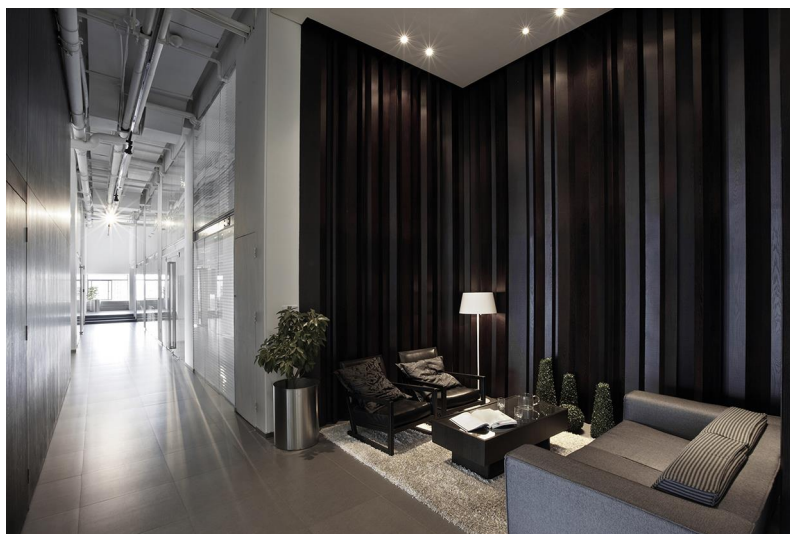

Spotlights



Downlights



Linear



Area



Floor | Wall



Free-standing



Street



Decorative



High bay

**Module SLA DC G2 50mm SNC**

Module SLA essence

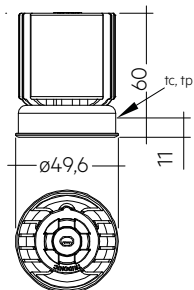

SLA DC G2 50mm 700lm SNC

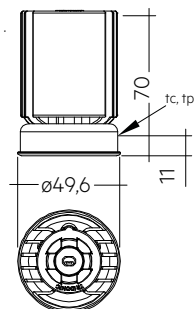

SLA DC G2 50mm 1200lm SNC

**Ordering data**

Type	Article number	Colour temperature	Packaging	Weight per pc.
SLA DC G2 50mm 700lm 927 24D SNC	28001942	2,700 K	80 pc(s).	0.090 kg
SLA DC G2 50mm 700lm 927 36D SNC	28001943	2,700 K	80 pc(s).	0.090 kg
SLA DC G2 50mm 700lm 930 24D SNC	28001944	3,000 K	80 pc(s).	0.090 kg
SLA DC G2 50mm 700lm 930 36D SNC	28001945	3,000 K	80 pc(s).	0.090 kg
SLA DC G2 50mm 700lm 940 24D SNC	28001946	4,000 K	80 pc(s).	0.090 kg
SLA DC G2 50mm 700lm 940 36D SNC	28001947	4,000 K	80 pc(s).	0.090 kg
SLA DC G2 50mm 1200lm 927 12D SNC	28002835	2,700 K	80 pc(s).	0.101 kg
SLA DC G2 50mm 1200lm 927 24D SNC	28001950	2,700 K	80 pc(s).	0.101 kg
SLA DC G2 50mm 1200lm 927 36D SNC	28001951	2,700 K	80 pc(s).	0.101 kg
SLA DC G2 50mm 1200lm 930 12D SNC	28002836	3,000 K	80 pc(s).	0.101 kg
SLA DC G2 50mm 1200lm 930 24D SNC	28001952	3,000 K	80 pc(s).	0.101 kg
SLA DC G2 50mm 1200lm 930 36D SNC	28001953	3,000 K	80 pc(s).	0.101 kg
SLA DC G2 50mm 1200lm 940 12D SNC	28002837	4,000 K	80 pc(s).	0.101 kg
SLA DC G2 50mm 1200lm 940 24D SNC	28001954	4,000 K	80 pc(s).	0.101 kg
SLA DC G2 50mm 1200lm 940 36D SNC	28001955	4,000 K	80 pc(s).	0.101 kg

**Technical data**

Ambient temperature $t_a$	-20 ... +40 °C
$t_p$ rated for SLA DC 700lm	60 °C
$t_p$ rated for SLA DC 1200lm	75 °C
$t_c$ for SLA DC 700lm	75 °C
$t_c$ for SLA DC 1200lm	90 °C
$I_{rated}$ for SLA DC 700lm	250 mA
$I_{rated}$ for SLA DC 1200lm	350 mA
$I_{max}$ for SLA DC 700lm	300 mA
$I_{max}$ for SLA DC 1200lm	380 mA
Max. perm. LF current ripple for SLA DC 700lm	900 mA
Max. perm. LF current ripple for SLA DC 1200lm	1,030 mA
Max. permissible peak current for SLA DC 700lm	1,260 mA / max. 10 ms
Max. permissible peak current for SLA DC 1200lm	1,450 mA / max. 10 ms
Max. working voltage for insulation	60 V
Insulation test voltage	0.5 kV
ESD classification of LED module	Severity level 2
Colour tolerance	3 SDCM
Risk group (IEC 62471)	RG1
Type of protection	IP20
Lumen maintenance L70B50	50,000 h
Guarantee (conditions at <a href="http://www.tridonic.com">www.tridonic.com</a> )	5 Year(s)

**Approval marks****Standards**

EN 62031, EN 62471, EN 61547

**Specific technical data**

Type	Photometric code	Forward current	Usefull luminous flux at $t_p$ rated <sup>①</sup>	Peak luminous intensity at $t_p$ rated <sup>②</sup>	Beam characteristic	Power consumption $P_{on}$ at $t_p$ rated	Min. forward voltage at $t_c$	Max. forward voltage at $t_a = -20$ °C	Efficacy of the module at $t_p$ rated	Colour rendering index CRI
SLA DC G2 50mm 700lm 927 24D SNC	927/359	250 mA	770 lm	2,920 cd	24°	8.8 W	30.0 V	40.0 V	88 lm/W	> 90
SLA DC G2 50mm 700lm 927 36D SNC	927/359	250 mA	770 lm	1,540 cd	36°	8.8 W	30.0 V	40.0 V	88 lm/W	> 90
SLA DC G2 50mm 700lm 930 24D SNC	930/359	250 mA	840 lm	3,192 cd	24°	8.8 W	30.0 V	40.0 V	95 lm/W	> 90
SLA DC G2 50mm 700lm 930 36D SNC	930/359	250 mA	840 lm	1,680 cd	36°	8.8 W	30.0 V	40.0 V	95 lm/W	> 90
SLA DC G2 50mm 700lm 940 24D SNC	940/359	250 mA	890 lm	3,382 cd	24°	8.8 W	30.0 V	40.0 V	101 lm/W	> 90
SLA DC G2 50mm 700lm 940 36D SNC	940/359	250 mA	890 lm	1,780 cd	36°	8.8 W	30.0 V	40.0 V	101 lm/W	> 90
SLA DC G2 50mm 1200lm 927 12D SNC	927/349	350 mA	958 lm	6,123 cd	12°	12.2 W	32.4 V	37.6 V	79 lm/W	> 90
SLA DC G2 50mm 1200lm 927 24D SNC	927/349	350 mA	1,140 lm	4,300 cd	24°	12.2 W	32.4 V	37.6 V	93 lm/W	> 90
SLA DC G2 50mm 1200lm 927 36D SNC	927/349	350 mA	1,140 lm	2,200 cd	36°	12.2 W	32.4 V	37.6 V	93 lm/W	> 90
SLA DC G2 50mm 1200lm 930 12D SNC	930/349	350 mA	962 lm	5,885 cd	12°	12.2 W	32.4 V	37.6 V	79 lm/W	> 90
SLA DC G2 50mm 1200lm 930 24D SNC	930/349	350 mA	1,170 lm	4,400 cd	24°	12.2 W	32.4 V	37.6 V	96 lm/W	> 90
SLA DC G2 50mm 1200lm 930 36D SNC	930/349	350 mA	1,170 lm	2,300 cd	36°	12.2 W	32.4 V	37.6 V	96 lm/W	> 90
SLA DC G2 50mm 1200lm 940 12D SNC	940/349	350 mA	1,021 lm	6,429 cd	12°	12.2 W	32.4 V	37.6 V	84 lm/W	> 90
SLA DC G2 50mm 1200lm 940 24D SNC	940/349	350 mA	1,270 lm	4,000 cd	24°	12.2 W	32.4 V	37.6 V	104 lm/W	> 90
SLA DC G2 50mm 1200lm 940 36D SNC	940/349	350 mA	1,130 lm	2,000 cd	36°	12.2 W	32.4 V	37.6 V	93 lm/W	> 90

① Tolerance of useful light flux - 0 % / + 15 %. Measurement uncertainty  $\pm$  10 %.② Tolerance of peak luminous intensity - 0 % / + 15 %. Measurement uncertainty  $\pm$  10 %.

## ACS TRIM RING

Accessory

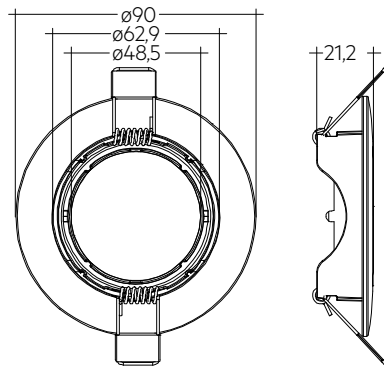
**Product description**

- \_ Up to 30° swivel mounting rings for ceiling cutouts 68 mm and 75 mm
- \_ Matt white / matt black / brushed nickel finishing
- \_ Version 75 mm with optional anti-glare guard
- \_ Spring clip pre-assembled

**Website**

<http://www.tridonic.com/28002184>

**Ordering data**

Type	Article number	Colour	Ceiling cutout	Packaging, carton	Weight per pc.
ACS TRIM RING SWIVEL 68mm WH 30°	28002184	White	ø 68 mm	90 pc(s).	0.064 kg
ACS TRIM RING SWIVEL 68mm BK 30°	28002185	Black	ø 68 mm	90 pc(s).	0.064 kg
ACS TRIM RING SWIVEL 68mm BN 30°	28002186	Chrome	ø 68 mm	90 pc(s).	0.064 kg
ACS TRIM RING SWIVEL 75mm WH 30°	28002187	White	ø 75 mm	90 pc(s).	0.100 kg
ACS TRIM RING SWIVEL 75mm BK 30°	28002188	Black	ø 75 mm	90 pc(s).	0.100 kg

## 1. Standards

EN 62031  
EN 62471  
EN 61547

### 1.1 Photometric code

Key for photometric code, e. g. 930 / 349

1 <sup>st</sup> digit	2 <sup>nd</sup> + 3 <sup>rd</sup> digit	4 <sup>th</sup> digit	5 <sup>th</sup> digit	6 <sup>th</sup> digit	
Code CRI	Colour temperature in Kelvin x 100	MacAdam initial	MacAdam after 25% of the lifetime (max.6000h)	Luminous flux after 25% of the lifetime (max.6000h)	
7 70 – 79				Code	Luminous flux
8 80 – 89				7	≥ 70 %
9 ≥90				8	≥ 80 %
				9	≥ 90 %

### 1.2 Energy classification

Type	Colour temperature	Forward current	Energy classification	Energy consumption
<b>SLA DC G2 50mm 700lm</b>				
SLA DC G2 50mm 700lm 927 24D SNC	2,700 K	250 mA	G	9 kWh / 1,000 h
SLA DC G2 50mm 700lm 927 36D SNC	2,700 K	250 mA	G	9 kWh / 1,000 h
SLA DC G2 50mm 700lm 930 24D SNC	3,000 K	250 mA	F	9 kWh / 1,000 h
SLA DC G2 50mm 700lm 930 36D SNC	3,000 K	250 mA	F	9 kWh / 1,000 h
SLA DC G2 50mm 700lm 940 24D SNC	4,000 K	250 mA	F	9 kWh / 1,000 h
SLA DC G2 50mm 700lm 940 36D SNC	4,000 K	250 mA	F	9 kWh / 1,000 h
<b>SLA DC G2 50mm 1200lm</b>				
SLA DC G2 50mm 1200lm 927 12D SNC	2,700 K	350 mA	G	13 kWh / 1,000 h
SLA DC G2 50mm 1200lm 927 24D SNC	2,700 K	350 mA	F	13 kWh / 1,000 h
SLA DC G2 50mm 1200lm 927 36D SNC	2,700 K	350 mA	F	13 kWh / 1,000 h
SLA DC G2 50mm 1200lm 930 12D SNC	3,000 K	350 mA	G	13 kWh / 1,000 h
SLA DC G2 50mm 1200lm 930 24D SNC	3,000 K	350 mA	F	13 kWh / 1,000 h
SLA DC G2 50mm 1200lm 930 36D SNC	3,000 K	350 mA	F	13 kWh / 1,000 h
SLA DC G2 50mm 1200lm 940 12D SNC	4,000 K	350 mA	G	13 kWh / 1,000 h
SLA DC G2 50mm 1200lm 940 24D SNC	4,000 K	350 mA	F	13 kWh / 1,000 h
SLA DC G2 50mm 1200lm 940 36D SNC	4,000 K	350 mA	F	13 kWh / 1,000 h

Energy label and further information at [www.tridonic.com](http://www.tridonic.com) in the certificates tab of the corresponding product page and at the EPREL data base <https://eprel.ec.europa.eu/>

## 2. Thermal details

### 2.1 tp point, ambient temperature and lifetime

The temperature at tp reference point is crucial for the light output and lifetime of a LED product.

For SLA DC G2 700lm a tp temperature of 60 °C and for SLA DC G2 1200lm a tp temperature of 75 °C has to be complied in order to achieve an optimum between light output and lifetime.

Compliance with the maximum permissible reference temperature at the tc point must be checked under operating conditions in a thermally stable state. The maximum value must be determined under worst-case conditions for the relevant application.

The tc and tp temperature of LED modules from Tridonic are measured at the same reference point.

### 2.2 Storage and humidity

storage temperature	-30...+80 °C
---------------------	--------------

Operation only in non condensing environment.  
Humidity during processing of the module should be < 85 %.

### 2.3 Thermal design and heat sink

The rated life of LED products depends to a large extent on the temperature. If the permissible temperature limits are exceeded, the life of the SLA will be greatly reduced or the SLA may be destroyed.

## 3. Installation / wiring

### 3.1 Electrical supply/choice of LED Driver

SLA modules from Tridonic are not protected against overvoltages, overcurrents, overloads or short-circuit currents. Safe and reliable operation can only be guaranteed in conjunction with a LED Driver which complies with the relevant standards. The use of LED Drivers from Tridonic in combination with SLA modules guarantees the necessary protection for safe and reliable operation.

If a LED Driver other than Tridonic is used, it must provide the following protection:

- Short-circuit protection
- Overload protection
- Overtemperature protection



SLA modules must be supplied by a constant current LED Driver. Operation with a constant voltage LED Driver will lead to an irreversible damage of the module. Wrong polarity can damage the SLA.

### 3.2 wiring

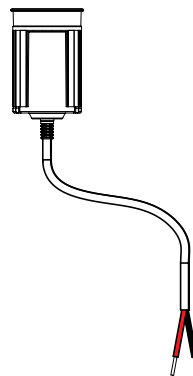

### 3.3 Wiring type and cross section

Cable type: VDE HO3VVH2-F 0.5 mm<sup>2</sup>  
Cable length: 460 mm  
Stripping length: 8 mm, pre-tinned

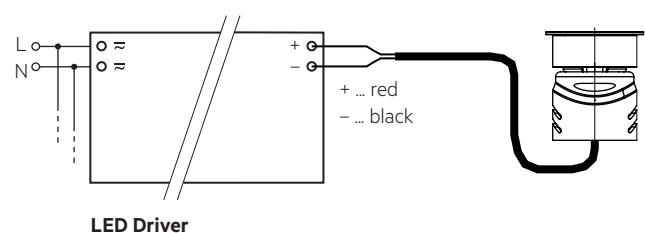

### 3.4 Mounting instruction

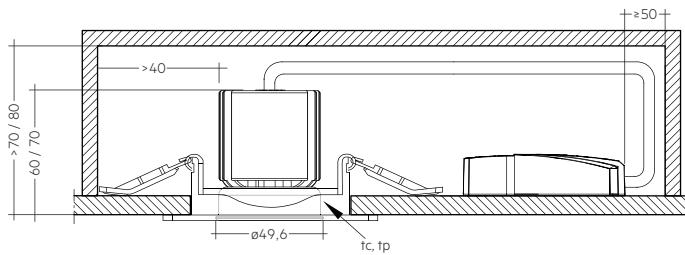

For mounting the SLA products it is necessary to have a assembling ring which is not provided.



Chemical substance may harm the LED module. Chemical reactions could lead to colour shift, reduced luminous flux or a total failure of the module caused by corrosion of electrical connections.

## 4. Lifetime

### 4.1 Lifetime, lumen maintenance and failure rate

The light output of an LED Module decreases over the lifetime, this is characterized with the L value. L70 means that the LED module will give 70 % of its initial luminous flux. This value is always related to the number of operation hours and therefore defines the lifetime of an LED module.

As the L value is a statistical value and the lumen maintenance may vary over the delivered LED modules. The B value defines the amount of modules which are below the specific L value, e.g. L70B10 means 10 % of the LED modules are below 70 % of the initial luminous flux, respectively 90 % will be above 70 % of the initial value.

In addition the percentage of failed modules (fatal failure) is characterized by the C value.

The F value is the combination of the B and C value. That means for F degradation and complete failures are considered, e.g. L70F10 means 10 % of the LED modules may fail or be below 70 % of the initial luminous flux.

### 4.2 Lumen maintenance

SLA DC 700lm:

Forward current	tp temperature	L90B10	L90B50	L80B10	L80B50	L70B10	L70B50
180 mA	50 °C	8,000 h	14,000 h	25,000 h	31,000 h	42,000 h	>50,000 h
	65 °C	8,000 h	14,000 h	25,000 h	31,000 h	42,000 h	>50,000 h
250 mA	60 °C	8,000 h	14,000 h	25,000 h	31,000 h	42,000 h	>50,000 h
	75 °C	8,000 h	13,000 h	25,000 h	31,000 h	42,000 h	>50,000 h

SLA DC 1200lm:

Forward current	tp temperature	L90B10	L90B50	L80B10	L80B50	L70B10	L70B50
250 mA	55 °C	>50,000 h	>50,000 h	>50,000 h	>50,000 h	>50,000 h	>50,000 h
	70 °C	>50,000 h	>50,000 h	>50,000 h	>50,000 h	>50,000 h	>50,000 h
350 mA	75 °C	>50,000 h	>50,000 h	>50,000 h	>50,000 h	>50,000 h	>50,000 h
	90 °C	>50,000 h	>50,000 h	>50,000 h	>50,000 h	>50,000 h	>50,000 h

### 3.5 EOS/ESD safety guidelines



The device / module contains components that are sensitive to electrostatic discharge and may only be installed in the factory and on site if appropriate EOS/ESD protection measures have been taken. No special measures need be taken for devices/modules with enclosed casings (contact with the pc board not possible), just normal installation practice.

For further information for EOS/ESD safety guidelines and the ESD classification please refer to the brochure entitled <http://www.tridonic.com/esd-protection>.

## 5. Photometric characteristics

### 5.1 Coordinates and tolerances according to CIE 1931

The specified colour coordinates are measured integral in thermal saturated stage at  $t_p$  rated.

The ambient temperature of the measurement is  $t_a = 25^\circ\text{C}$ .

The measurement tolerance of the colour coordinates are  $\pm 0.01$ .

Module type	Current impulse	$t_p$ rated
SLA DC G2 700lm	250 mA	60 °C
SLA DC G2 1200lm	350 mA	75 °C

#### 2,700 K

	x0	y0	
Centre SLA DC G2 700lm	0.4579	0.4114	—————
Centre SLA DC G2 1200lm	0.4578	0.4105	- - - - -

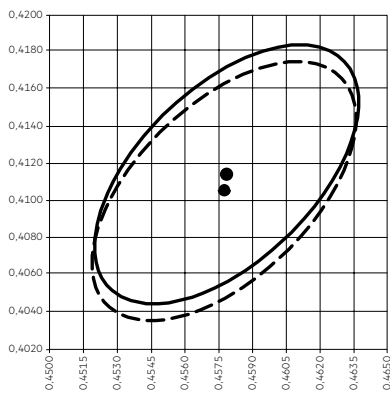

MacAdam ellipse: 3SDCM

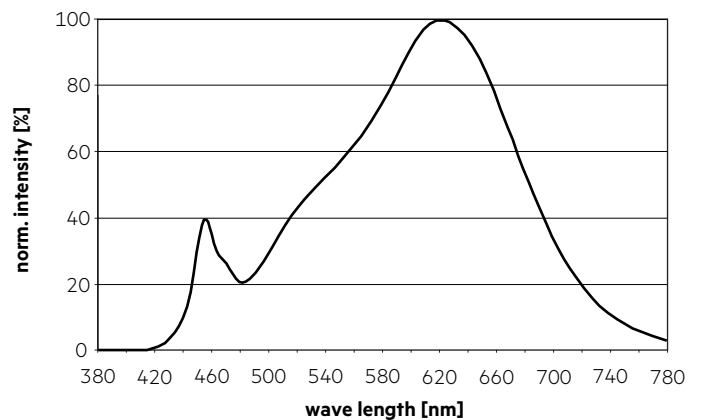

#### 3,000 K

	x0	y0	
Centre SLA DC G2 700lm	0.4341	0.4047	—————
Centre SLA DC G2 1200lm	0.4339	0.4036	- - - - -

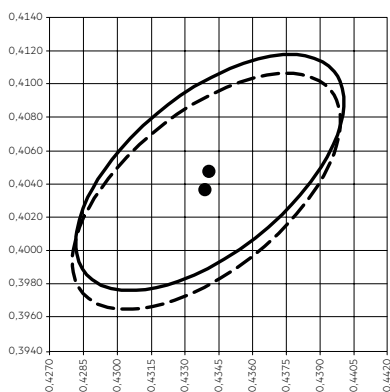

MacAdam ellipse: 3SDCM

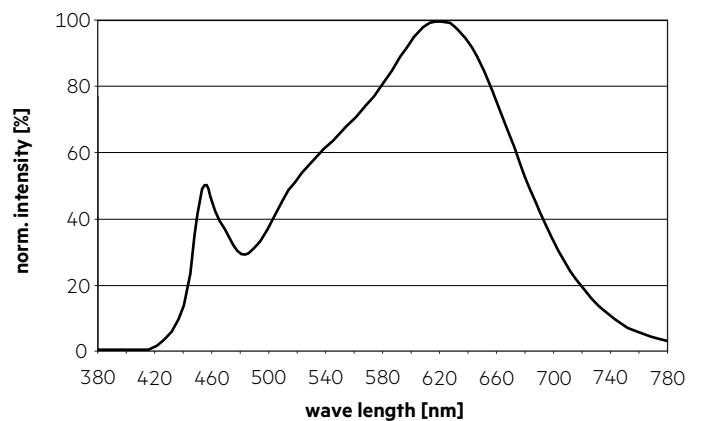

4,000 K

	x0	y0	
Centre SLA DC G2 700lm	0.3825	0.3817	—————
Centre SLA DC G2 1200lm	0.3820	0.3804	- - - - -

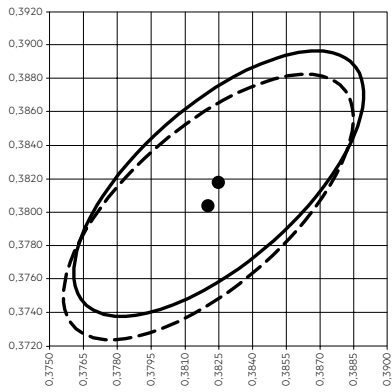

MacAdam ellipse: 3SDCM

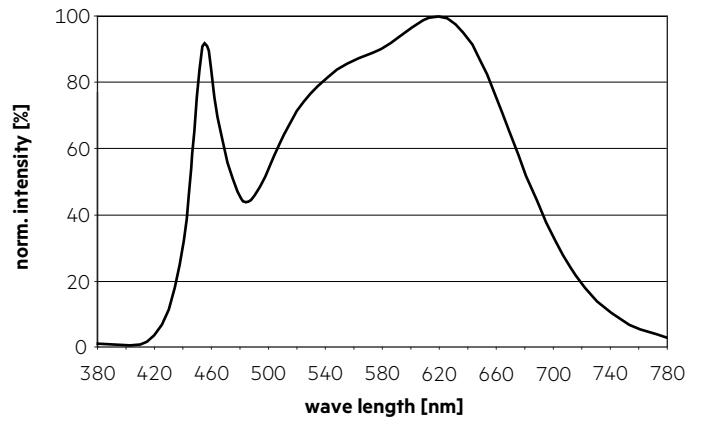

5.2 Light distribution

Light distribution for 12D

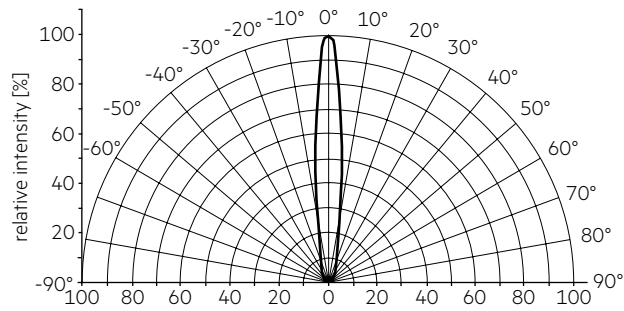

Light distribution for 24D

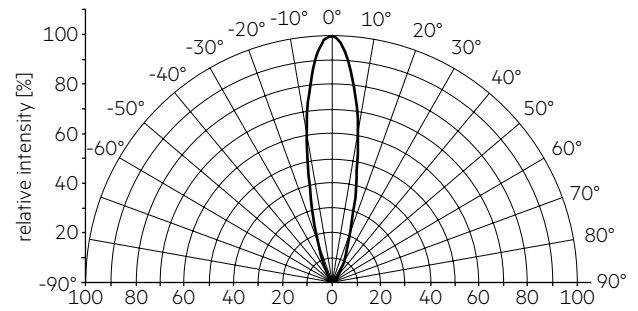

Light distribution for 36D

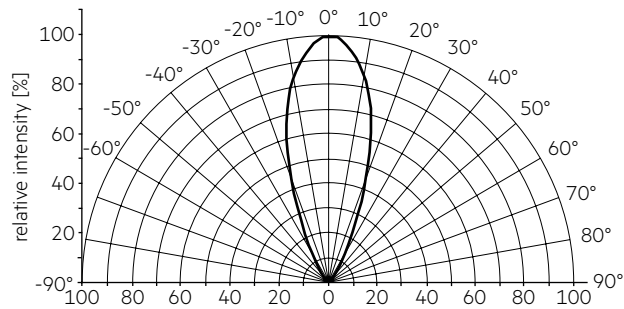



### 5.3 Relative luminous flux vs. tp temperature

SLA DC G2 50mm 700lm 9xx SNC

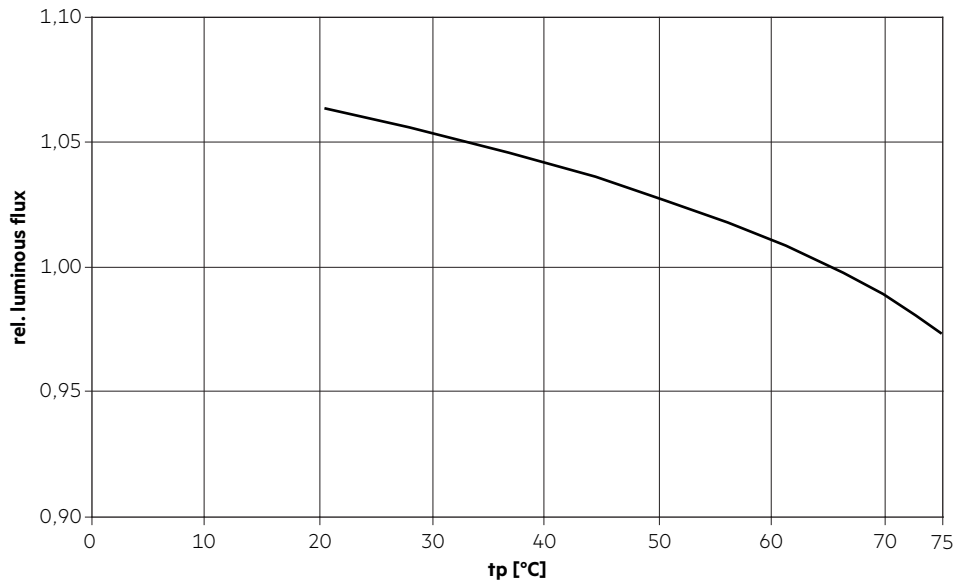

SLA DC G2 50mm 1200lm 9xx SNC

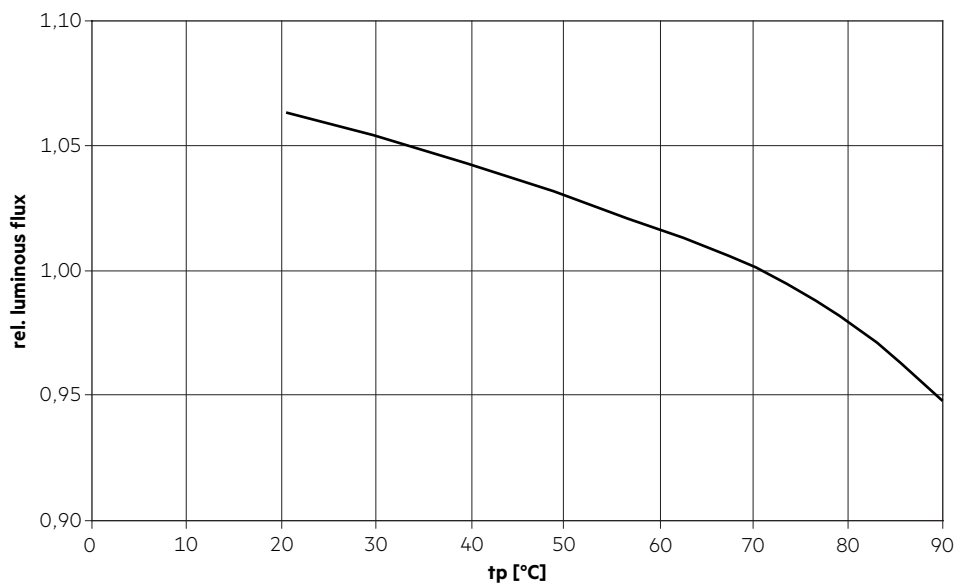

## 6. Miscellaneous

### 6.1 Additional information

Additional technical information at [www.tridonic.com](http://www.tridonic.com) → Technical Data

Guarantee conditions at [www.tridonic.com](http://www.tridonic.com) → Services

Lifetime declarations are informative and represent no warranty claim.